



Canning Lines  
Table Top  
Modular  
Conveyors  
Fillers  
Glass Plants  
Air Conveyors  
Case Packers  
Bottle Lines  
Rinsers

## Conveyor Components for the Bottling & Canning Industries



[www.pobcoplastics.com](http://www.pobcoplastics.com)

## Custom Star Wheels

Made to order only. Print and STEP files are required.  
UHMW & Acetal  
Colors: Natural, Blue, Black, Green

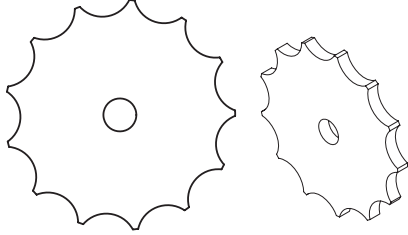

## Custom Nozzle Heads

Made to Order only. Print and STEP files are required.  
Acetal & POBLON (High-Temp)

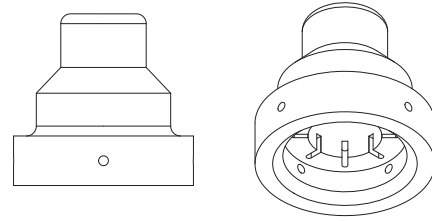

## Modular Transfer Plates

Stock Sizes Available with Gray Acetal Beads or  
Stainless Rollers

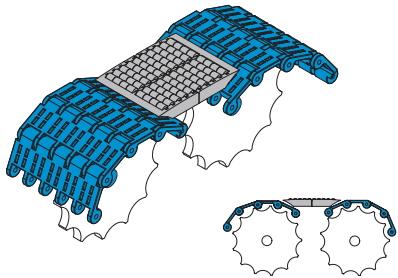

## Custom Wear Pads and Transfer Plates

Made to order only. UHMW & Acetal  
Colors: Natural, Blue, Black, Green

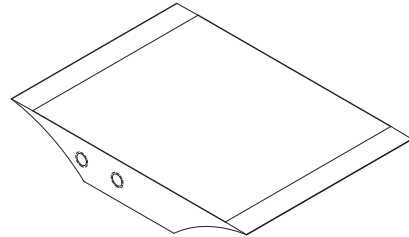

## POBCO Round Top Guide Rails

Used for Side Guides

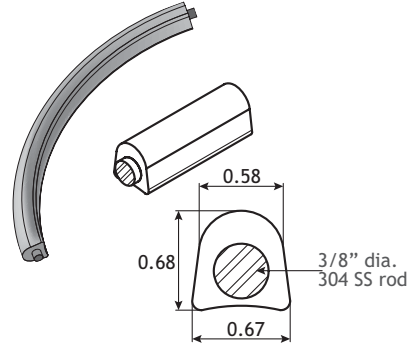
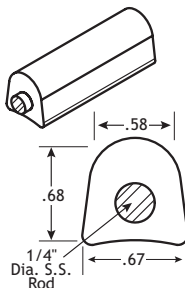
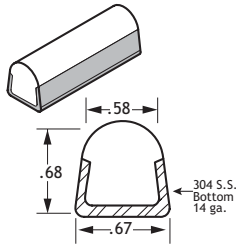

GRA-ROUND  
10ft & 20ft Lengths

GRA-1008-SS

GRA-109SS

Bendable by hand, 10ft Lengths

## POBCO Wearstrips for Table Top & Modular Chain

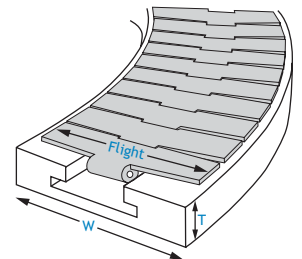
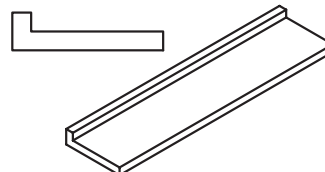
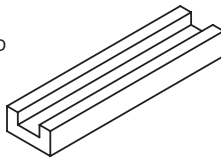
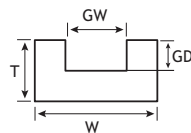
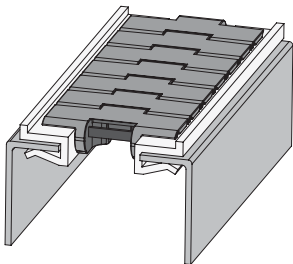

Flat Bar Clip-Ons

Channel Guides

Angles

Chain Track Wear Strip

# POBCO Neck Guides for PET Bottles on Air Conveyors

Neck Guides for high speed air conveying applications. Discuss your application with our Sales Department for material selection. Most options in stock.

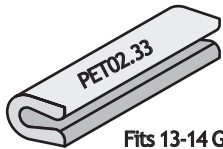

Fits 13-14 Ga.

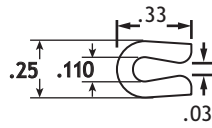

PART NUMBER	MATERIAL
PET02.33P	Plus (Lube Filled UHMW)
PET02.33HPG	High Performance (Gray UHMW)
PET02.33HP	High Performance (Red UHMW)



Fits 13-14 Ga.

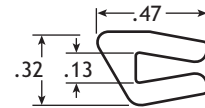

PART NUMBER	MATERIAL
PET02.47P	Plus (Lube Filled UHMW)

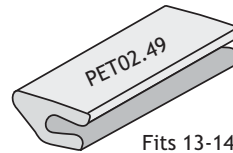

Fits 13-14 Ga.

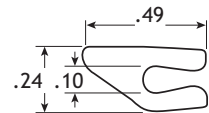

PET02.49HPG	High Performance (Gray UHMW)
PET02.49HP	High Performance (Red UHMW)

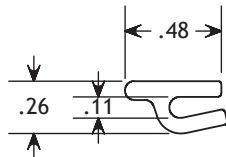
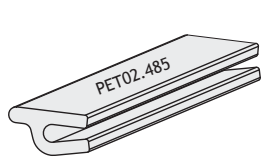

PET02.485HPGC250	High Performance (Gray UHMW)
------------------	------------------------------

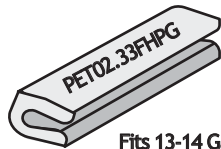

Fits 13-14 Ga.

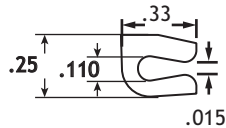

PET02.33FHPG	High Performance (Gray UHMW)
--------------	------------------------------



Fits 13-14 Ga.

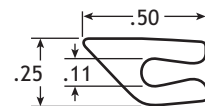

PET02.50U	Ultra-D (UHMW)
PET02.50P	Plus (Lube Filled UHMW)
PET02.50HP	High Performance (Red UHMW)

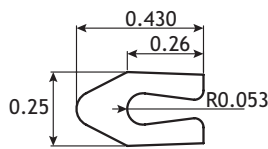
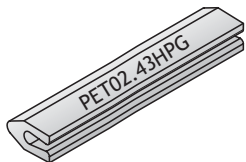

PET02.43HPG	High Performance (Gray UHMW)
-------------	------------------------------

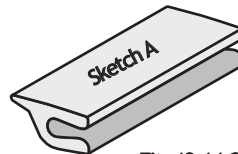

Fits 13-14 Ga.

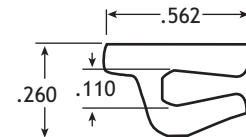

PET02.56SHP (Sketch A)	High Performance (Red UHMW)
PET02.56LHP (Sketch B)	

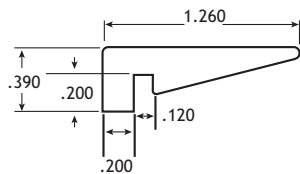
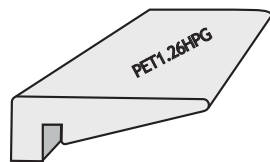
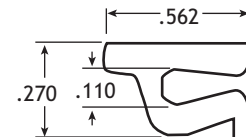

PET1.26HPG	High Performance (Gray UHMW)
------------	------------------------------

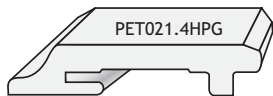

PET021.4HPG	High Performance (Gray UHMW)
-------------	------------------------------



Fits 13-14 Ga.

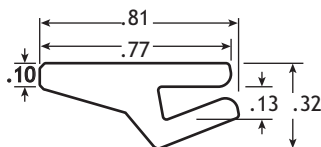

PET02.81HPG	High Performance (Gray UHMW)
PET02.81SD	Static-Reduced (Black UHMW)
PET02.81HP	High Performance (Red UHMW)

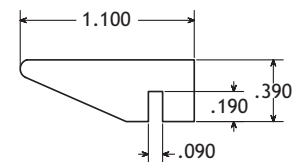
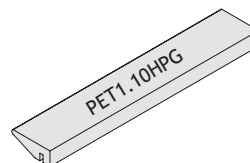

PET1.10HPG	High Performance (Gray UHMW)
------------	------------------------------

## POBCO Half Round Snap-Ons

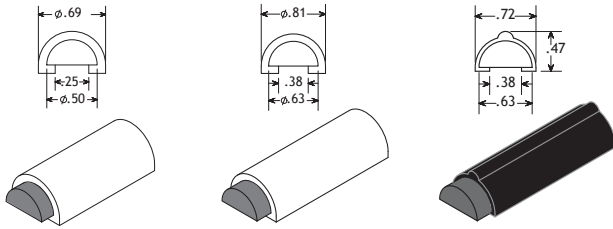

HRU-081106  
(UHMW)  
To Fit 1/2"

HRU-101307  
(UHMW)  
To Fit 5/8"

HRG-101208  
(Nylon-MD)  
To Fit 5/8"

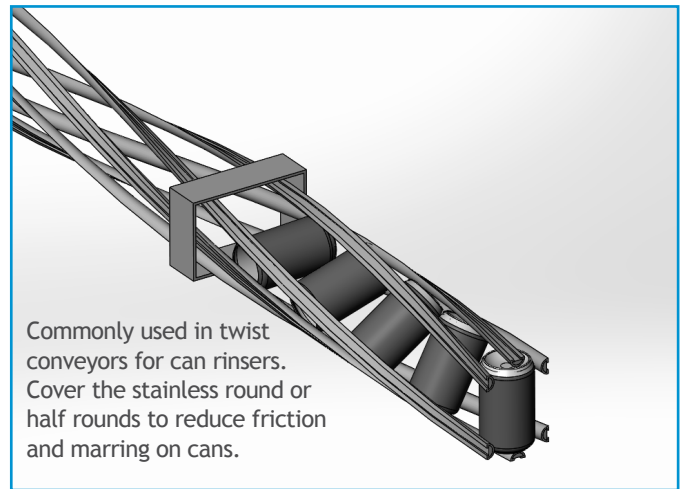

Commonly used in twist conveyors for can rinsers. Cover the stainless round or half rounds to reduce friction and marring on cans.

## POBCO Full Round Snap-Ons

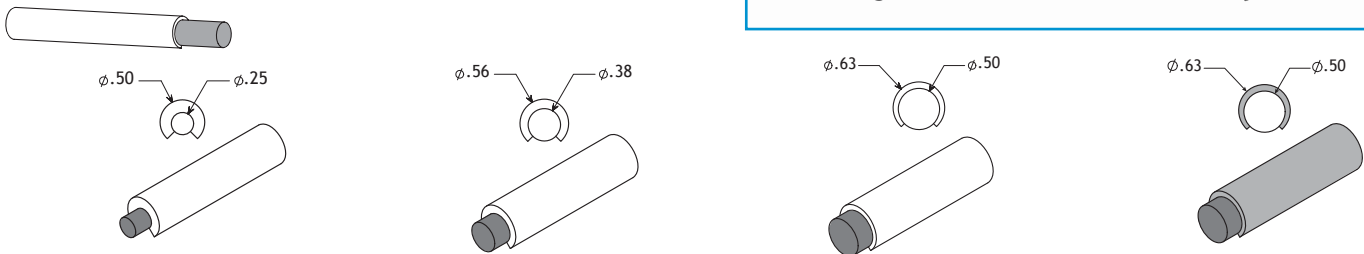

1/4" Full Round  
Snap-On  
FRU-0408 (UHMW)

3/8" Full Round  
Snap-On  
FRU-0609 (UHMW)

1/2" Full Round  
Snap-On  
FRU-0811 (UHMW)

1/2" Full Round  
Snap-On  
FRP-0811  
Lube-Filled UHMW

## POBCO Guides - Aluminum Rail with UHMW Covers

Used for Conveyor side guides for glass, bottles and can lines.

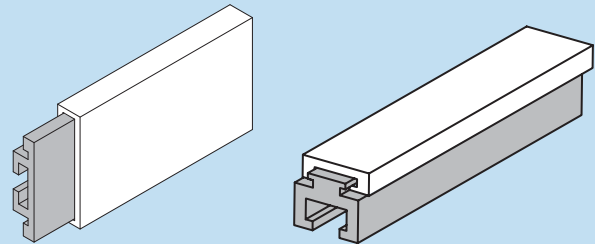

## POBCO Pet Bottle Straight Neck Guide Rails

European Style (Overhead Transport of Pet Bottles)

### Available Materials:

- UHMW - Static-Reduced Black
- Green or Black Repro
- Hi-Wear UHMW - Green or Black

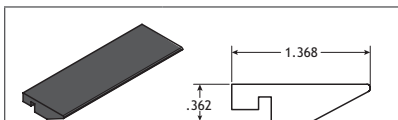

PART NUMBER	MATERIAL
CPNECKGUIDE	Black Hi-Wear UHMW

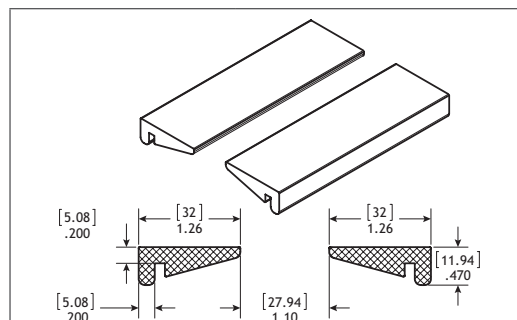

PART NUMBER	MATERIAL
PET288BURG	Green Repro UHMW
PET288BURB	Black Repro UHMW
PET288BCPGREEN	Green Hi-Wear UHMW
PET288BCPBLACK	Black Hi-Wear UHMW

STANDARD LENGTHS = 120"

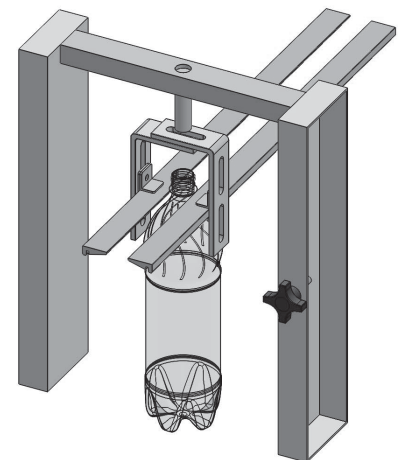

# POBCO Roller Chain Guides and Rectangular Wear Strip

## Materials:

- POBCO Ultra-D (UHMWPE)
- POBCO Plus (Food Grade Fluid Lube-Filled UHMWPE)
- POBCO SRU (Static Reduced UHMWPE)
- POBCO Hi-Wear (Longer Life)
- POBCO Blue UXC (low friction)
- POBCO Hi-Temp and PTFE Grades
- POBCO-B (Self-Lubricating Hardwood)\*

\*Preferred by Glass Plants

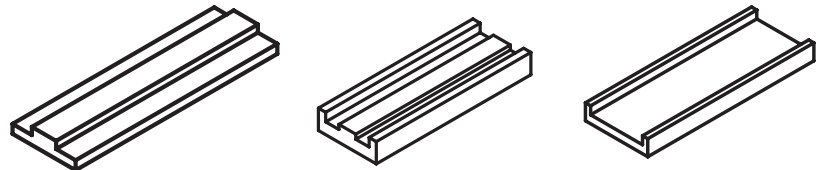
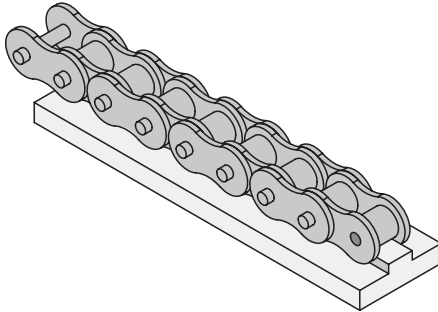
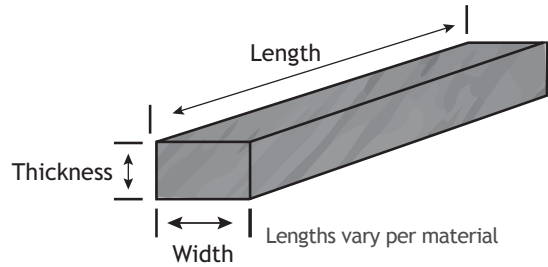

## POBCO Captured Chain Guides Used in Case Packing Conveyors

POBCO Anodized Aluminum (6063-T6 alloy) Chain Guides are fitted with white or green UHMW or POBCO Plus (Fluid Lube-Filled UHMW). POBCO Plus significantly reduces friction.

Note: 10FT of Aluminum Requires 20FT of Chain Guide Insert. UHMW inserts are available in 10FT lengths only.

<table border="1"> <thead> <tr> <th>ANSI CHAIN #</th> <th>T</th> <th>W</th> <th>B</th> <th>PART NUMBER</th> </tr> </thead> <tbody> <tr> <td>40</td> <td>1-7/16</td> <td>1-3/8</td> <td>1/16</td> <td>GRA-2322-40</td> </tr> <tr> <td>50</td> <td>1-7/16</td> <td>1-3/8</td> <td>1/16</td> <td>GRA-2322-50</td> </tr> <tr> <td>60</td> <td>1-7/16</td> <td>1-3/8</td> <td>1/16</td> <td>GRA-2322-60</td> </tr> <tr> <td>80</td> <td>1-11/16</td> <td>1-5/8</td> <td>1/8</td> <td>GRA-2726-80</td> </tr> </tbody> </table>	ANSI CHAIN #	T	W	B	PART NUMBER	40	1-7/16	1-3/8	1/16	GRA-2322-40	50	1-7/16	1-3/8	1/16	GRA-2322-50	60	1-7/16	1-3/8	1/16	GRA-2322-60	80	1-11/16	1-5/8	1/8	GRA-2726-80	<table border="1"> <thead> <tr> <th>ANSI CHAIN #</th> <th>T</th> <th>W</th> <th>B</th> <th>PART NUMBER</th> </tr> </thead> <tbody> <tr> <td>40</td> <td>1-23/32</td> <td>1-3/8</td> <td>1/16</td> <td>GRA-2822-40</td> </tr> <tr> <td>50</td> <td>1-23/32</td> <td>1-3/8</td> <td>1/16</td> <td>GRA-2822-50</td> </tr> <tr> <td>60</td> <td>1-23/32</td> <td>1-3/8</td> <td>1/16</td> <td>GRA-2822-60</td> </tr> </tbody> </table>	ANSI CHAIN #	T	W	B	PART NUMBER	40	1-23/32	1-3/8	1/16	GRA-2822-40	50	1-23/32	1-3/8	1/16	GRA-2822-50	60	1-23/32	1-3/8	1/16	GRA-2822-60	<table border="1"> <thead> <tr> <th>ANSI CHAIN #</th> <th>T</th> <th>W</th> <th>B</th> <th>PART NUMBER</th> </tr> </thead> <tbody> <tr> <td>40</td> <td>2-1/8</td> <td>1-1/32</td> <td>1/16</td> <td>GRA-3416-40</td> </tr> <tr> <td>50</td> <td>2-1/8</td> <td>1-1/32</td> <td>1/16</td> <td>GRA-3416-50</td> </tr> <tr> <td>60</td> <td>2-1/8</td> <td>1-1/32</td> <td>1/16</td> <td>GRA-3416-60</td> </tr> </tbody> </table>	ANSI CHAIN #	T	W	B	PART NUMBER	40	2-1/8	1-1/32	1/16	GRA-3416-40	50	2-1/8	1-1/32	1/16	GRA-3416-50	60	2-1/8	1-1/32	1/16	GRA-3416-60
ANSI CHAIN #	T	W	B	PART NUMBER																																																															
40	1-7/16	1-3/8	1/16	GRA-2322-40																																																															
50	1-7/16	1-3/8	1/16	GRA-2322-50																																																															
60	1-7/16	1-3/8	1/16	GRA-2322-60																																																															
80	1-11/16	1-5/8	1/8	GRA-2726-80																																																															
ANSI CHAIN #	T	W	B	PART NUMBER																																																															
40	1-23/32	1-3/8	1/16	GRA-2822-40																																																															
50	1-23/32	1-3/8	1/16	GRA-2822-50																																																															
60	1-23/32	1-3/8	1/16	GRA-2822-60																																																															
ANSI CHAIN #	T	W	B	PART NUMBER																																																															
40	2-1/8	1-1/32	1/16	GRA-3416-40																																																															
50	2-1/8	1-1/32	1/16	GRA-3416-50																																																															
60	2-1/8	1-1/32	1/16	GRA-3416-60																																																															



POBCO, Inc.  
99 Hope Ave | Worcester, MA 01603  
508.791.6376 | 1.800.222.6376  
pobco@pobcoplastics.com | www.pobcoplastics.com

©2019 POBCO Inc.

5M 7/2019